

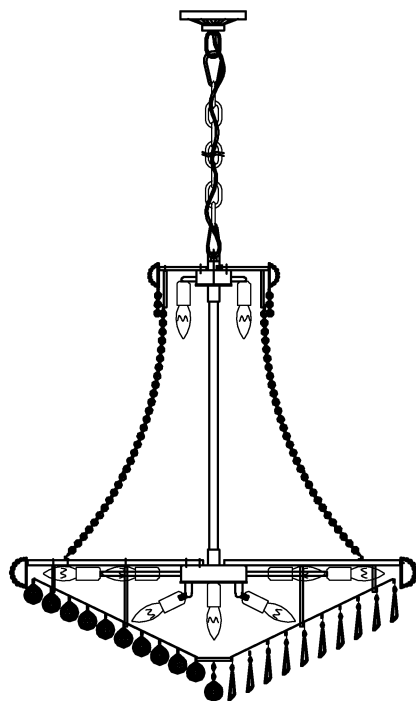

Trade Mark:  
CRYSTAL WORLD INC





Product Name: Pendant lamp  
Model :8040P36C  
120Vac, 60Hz,AC ONLY  
Lamp Size:Ø36"\*H41"

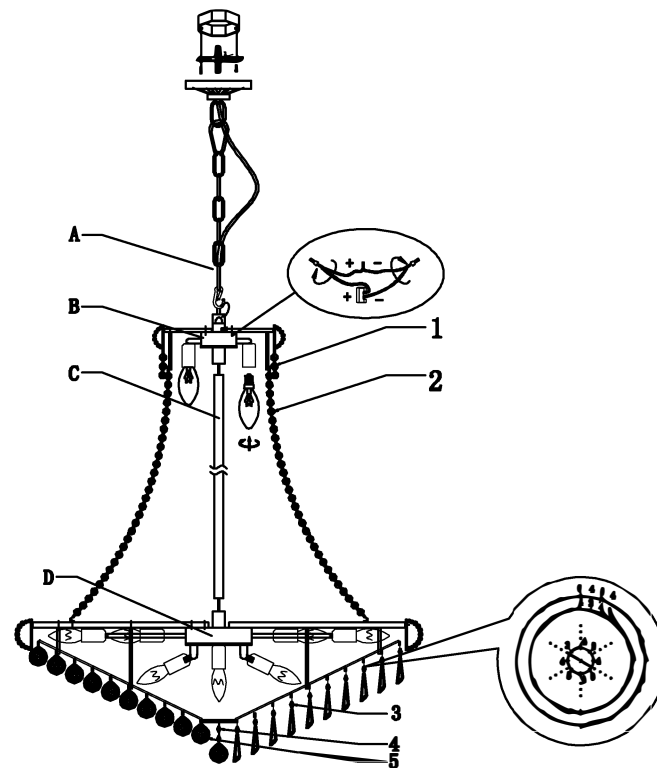

## PENDANT LAMP ASSEMBLY INSTRUCTIONS

- 1.Screw part (C) onto the part (D) secure with screw.
- 2.Screw part (B) onto the part (C) secure with screw.
- 3.Please fix (A) with (B).
- 4.Please wear gloves when you hanging the crystal.
- 5.Install bulbs( NOT INCLUDED),USE 120V E12  20\*40W Max.



 <b>1</b> 14mm*3pcs <b>49PCS</b>	 <b>2</b> 14mm*30pcs <b>49PCS</b>	 <b>3</b> 14mm*1pcs 63mm*1pcs <b>220PCS</b>	 <b>4</b> 40mm*1PCS <b>220PCS</b>	 <b>5</b> 14mm*2PCS 40mm*1PCS <b>1PCS</b>
--	---	--	---	--

