

Trade Mark:  
CRYSTAL WORLD INC

Product Name: Wall lamp  
Model :5532W21C-2  
120Vac, 60Hz,AC ONLY  
Lamp Size:W21"xH10"xE5"

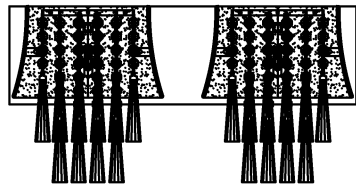



Intertek  
4006677

## WALL LAMP ASSEMBLY INSTRUCTIONS

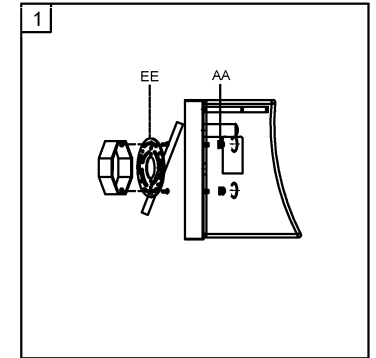
- Place fixture(A) onto Butterfly (EE).  
Secure with cap nuts (AA).



### Hardware Used

AA Cap nut		X 2
DD Mounting screw		X 2

- Please hang the crystal (1) (2) to the fixture .

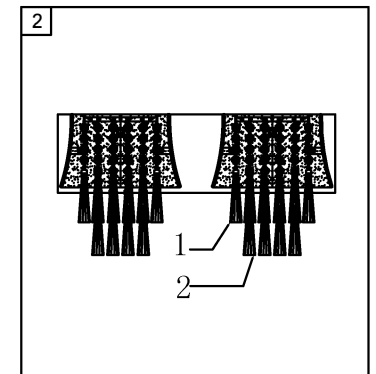
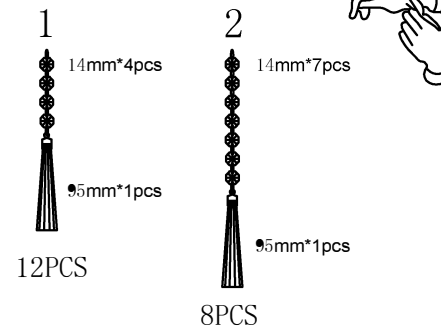

- Install light bulbs ( not included).  
Use bulb  
**120V G9**  **2\*40W Max.**

