

Trade Mark:
CRYSTAL WORLD INC

Product Name: Wall lamp
Model :5464W12DB-1
120Vac, 60Hz,AC ONLY
Lamp Size:W12"*H12"*E7"

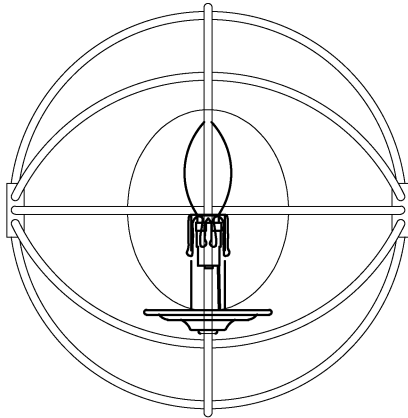

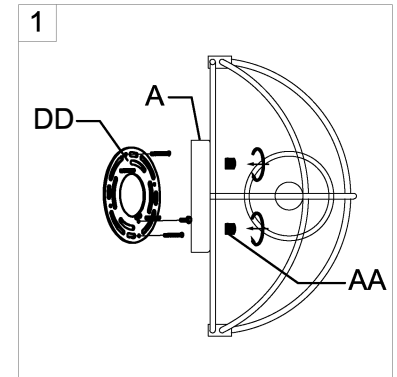

WALL LAMP ASSEMBLY INSTRUCTIONS

1.Place fixture(A)onto mounting screws (DD).Secure with cap nuts (AA).





Hardware Used

DD Mounting screw 
AA Cap nut 

2.Please fix(B) with (A) .

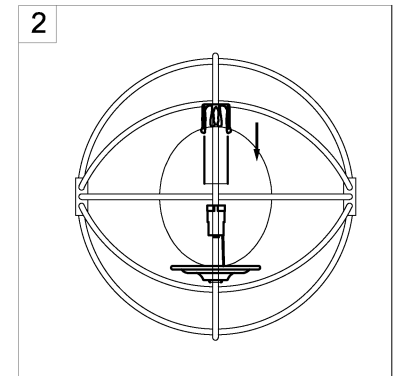
B 
1PCS



3.Install bulbs (NOT INCLUDED).
USE
120V E12  1*40W Max.

