







Assembly Instruction Sheet #HS-1120P32 For Style 1120P32

Tools Required: Flathead screwdriver, Phillips screwdriver, pliers, wire cutters, wire strippers, electrical tape, safety glasses.

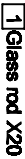
Light Sources: (12) G9 MAX 40W (not included).
Estimated Assembly Time: 20-30 minutes
Preparation: Identify and label all parts before beginning installation. Check package content list and designate labor to be sure all parts are present. If any parts are missing or damaged, do not attempt to assemble, install, or operate the fixture. Contact customer service for replacement parts.

⚠ Warnings and Cautions
 Turn off electricity at circuit breaker or main fuse box before installation. Consult a licensed electrician if in doubt. These instructions are provided for your safety. It is very important you read them completely before installing the fixture. We strongly recommend that a licensed, professional electrician perform the installation. Disconnect fixture from power source before replacing bulbs. Make sure bulbs are given sufficient time to cool before removal.

Package Contents

-  1 Glass rod X20
-  2 Glass rod X42
-  3 Glass rod X19
-  4 Glass rod X21
-  5 Glass rod X21
-  A Fixture Body X1
-  B Metal Ring X1

Hardware Contents

PART	DESCRIPTION	QUANTITY
AA	Cap nut	4pcs
BB	Wire nut	3pcs
CC	Outlet Box Screw	2pcs
DD	Mounting Screw	4pcs
EE	Mounting bracket	1pc

STEP 1 - Attach Mounting Screws, Lock Washers and Hex Nuts to Mounting Bracket.
 A. Line up a set of holes on the Mounting bracket (EE) and Holes on the ceiling canopy. Thread Mounting Screws (DD) into the holes on the Mounting bracket (EE). Place Lock Washers and Thread Hex Nuts onto the Mounting Screws (DD). Hand tighten until snug.

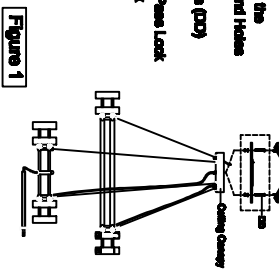

Figure 1

STEP 2 - Attach Mounting Bracket to Outlet Box
 A. Press the supply wires through the Mounting Bracket (EE). Attach the Mounting bracket (EE) to the Outlet Box with the head of the Green Ground Screw (CC). Secure it with Outlet Box Screws (CC). Tighten until snug.

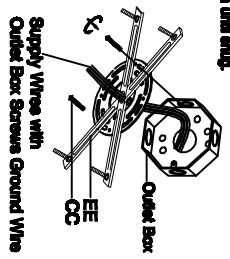

Figure 2

STEP 3 - Fit Ceiling Canopy to Mounting Bracket Assembly
 A. Fit the ceiling canopy to Mounting Screws (DD) and secure with Cap nut (AA). Note: The ceiling canopy should be snug against the ceiling and the Cap nut (AA). If not, adjust the length of the Mounting Screws (DD) by unscrewing the Hex Nut and Lock Washer and then screwing Mounting Screws (DD) in or out of the Mounting bracket (EE) until the correct length is achieved. Once the ceiling canopy is secure, remove the Cap nut (AA) and proceed to Step 4.

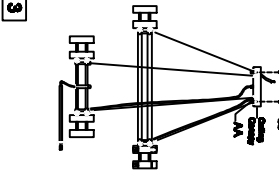

Figure 3

STEP 4 - Wire Connections
 A. Use standard wire connectors to make all wire connections. Twist connectors until wires are tightly joined together. Wrap each connection with approved electrical tape and carefully stuff all the connected wires into the Outlet Box.

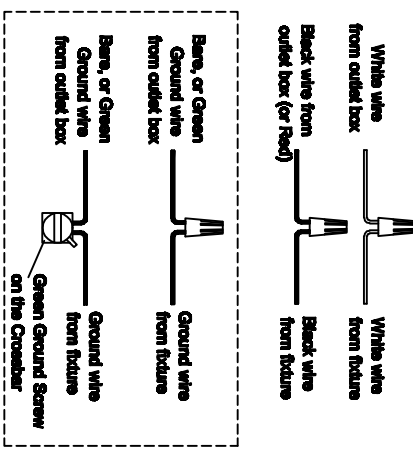

Figure 4

STEP 5 - Install Ceiling Canopy to Ceiling
 A. Carefully tuck all wires into the outlet box and position the ceiling canopy of the Fixture Body (A) over the outlet box. Align the holes in the ceiling canopy with the Mounting Screws (DD). Secure with Mounting Screws (AA) and hand tighten until snug.

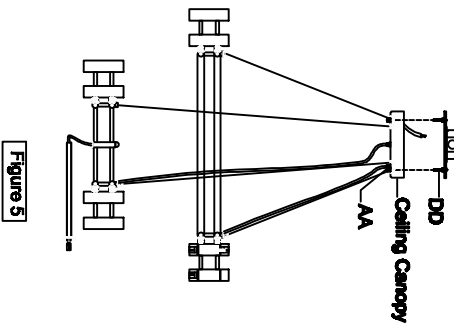

Figure 5

STEP 6 - Install Metal Ring to Fixture Body
 A. Connect the connector. Lock the metal cover on the metal Ring. Install one end of the middle rod on the main body and one end on the metal Ring.

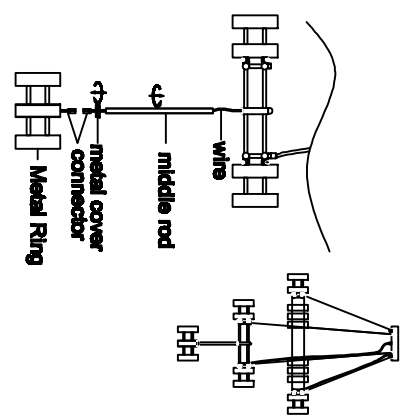

Figure 6

STEP 7 - Install Bulbs and Glass rod.
 A. Install bulbs into sockets and push snugly into place.
 B. Attach Glass rod to Fixture's Body.

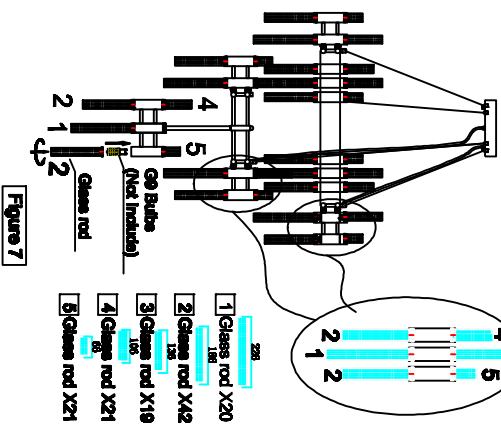

Figure 7