

Assembly Instruction Sheet #IS-1086W12 For Style 1086W12

Tools Required: Flathead screwdriver, Phillips screwdriver, pliers, wire cutters, wire strippers, electrical tape, safety glasses.
Light Source: (1) 120V LED 12W DIMMABLE (6000K).
Estimated Assembly Time: 18-30 minutes.
Preparation: Identify and inspect all parts before beginning installation. Check package content list and diagnose before to be sure all parts are present. If any parts are missing or damaged, do not attempt to assemble, install, or operate the fixture. Contact customer service for replacement parts.

⚠ Warnings and Cautions
 Turn off electricity at circuit breaker or main fuse box before installation. Consult a licensed electrician if in doubt. These instructions are provided for your safety. It is very important you read them completely before installing the fixture. We strongly recommend that a licensed, professional electrician perform the installation. Disconnect fixture from power source before replacing bulbs. Make sure bulbs are given sufficient time to cool before removal.

Package Contents

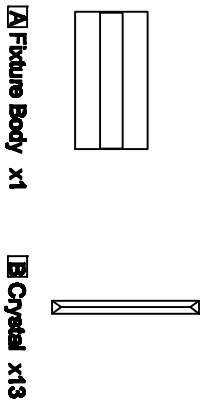

A Fixture Body x1 **B** Crystal x13

Hardware Contents

PART	DESCRIPTION	QUANTITY
AA	Wire nut	2pcs
BB	Outlet Box Screw	2pcs



STEP 1 - Release Mounting bracket from Ceiling Canopy .

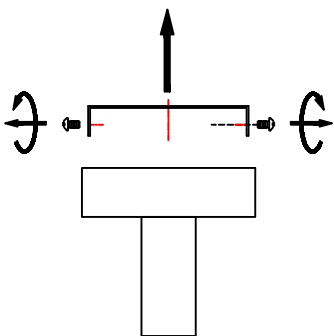

Figure 1

STEP 2 - Attach Mounting bracket to Outlet Box
 A. Pass the supply wires through the Mounting bracket (DD). Attach the Mounting bracket (DD) to the Outlet Box with the head of the Green Ground Screw facing you. Secure it with Outlet Box Screws. Tighten until snug.

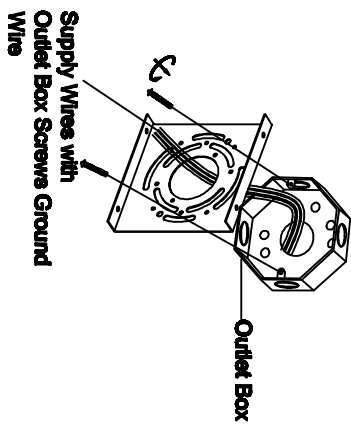

Figure 2

STEP 3 - Wire Connections
 A. Use standard wire connections to make all wire connections. Twist conductors until wires are tightly joined together. Wrap each connection with approved electrical tape and carefully stuff all the connected wires into the Outlet Box.

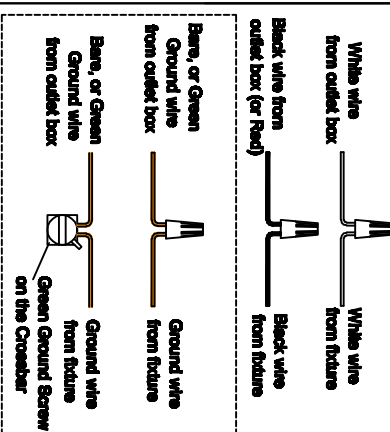

Figure 3

STEP 4 - Install Ceiling Canopy to Ceiling

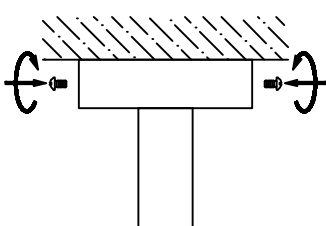

Figure 4

STEP 5 - Install Crystal .

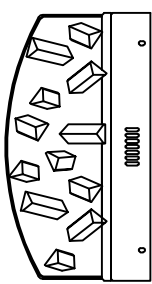
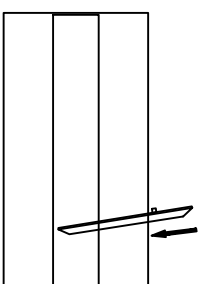

Figure 5