



2-way no share Type T/P coaxial complete valve  
**GN44+**



## Specifications

### Composition

- TGN44+C - 2-way no share Type T/P coaxial valve trim
- R23 - 2-way Type T/P coaxial valve rough

### Available colors

- C : Chrome
- BN : Brushed Nickel (PVD)
- PN : Polished Nickel (PVD)

### Available flows

- 24 L/min, 6.3 gpm (US) 60psi
- Type TP - For use with shower heads rated at 7L/min (1.8 gpm) or higher

### Certifications

- CSA B125.1
- ASME A112.18.1
- ASSE 1016
- CMR248 Approval

cUPC®

## Warranty

This **Riobel Inc.** product you have purchased carries a Limited Lifetime Warranty on the chrome, PVD finish, blacks and all working parts and is guaranteed from the initial purchase date against all manufacturing defects. All other finishes, including plastic components, are guaranteed for one year. All electric and/or electronic parts are covered by a 5-year limited warranty.

## Customer Service

Ontario, West Canada : 888-287-5354 Quebec, Maritimes, United States : 866-473-8442

2020.06.13



2-way no share Type T/P coaxial valve trim  
**TGN44+**



cUPC®

## Specifications

### Descriptions

- R23, R23-SPEX or R23-EX rough required to complete
- Thermostatic/pressure balance coaxial cartridge with check valves
- Trim only
- 3 positions (OFF, 1, 2) no share

### Available colors

- C : Chrome
- BN : Brushed Nickel (PVD)
- PN : Polished Nickel (PVD)

### Certifications

- CSA B125.1
- ASME A112.18.1
- ASSE 1016
- CMR248 Approval

## Warranty

This **Riobel Inc.** product you have purchased carries a Limited Lifetime Warranty on the chrome, PVD finish, blacks and all working parts and is guaranteed from the initial purchase date against all manufacturing defects. All other finishes, including plastic components, are guaranteed for one year. All electric and/or electronic parts are covered by a 5-year limited warranty.

## Customer Service

Ontario, West Canada : 888-287-5354 Quebec, Maritimes, United States : 866-473-8442



2-way Type T/P coaxial valve rough  
**R23**



# Specifications

## Descriptions

- Test cap
- Service valves
- ½" inlet male NPT or sweat
- Two ½" outlets male NPT or sweat
- TXX23XX or TXX44XX trim required to complete
- Rough only

## Available colors

- :

## Certifications

- CSA B125.1
- ASME A112.18.1
- ASSE 1016
- CMR248 Approval

UPC®

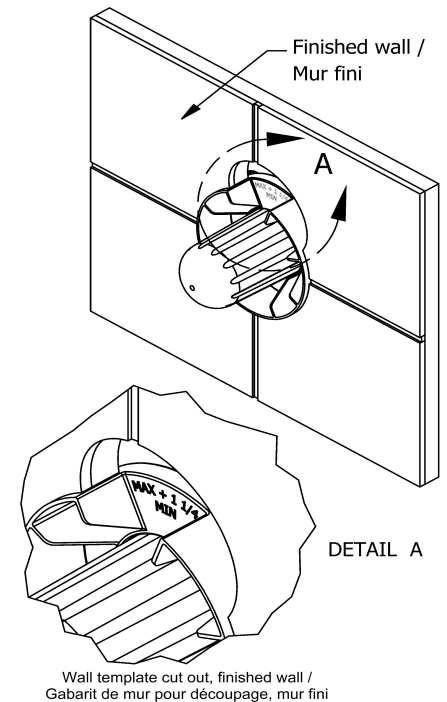
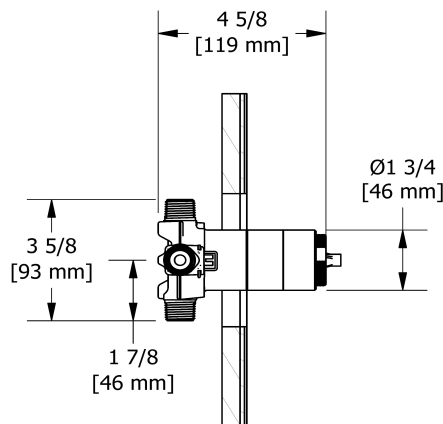

Sizes, models and finishes may differ from thoses presented.

## Warranty

This **Riobel Inc.** product you have purchased carries a Limited Lifetime Warranty on the chrome, PVD finish, blacks and all working parts and is guaranteed from the initial purchase date against all manufacturing defects. All other finishes, including plastic components, are guaranteed for one year. All electric and/or electronic parts are covered by a 5-year limited warranty.

## Customer Service

Ontario, West Canada : 888-287-5354 Quebec, Maritimes, United States : 866-473-8442